

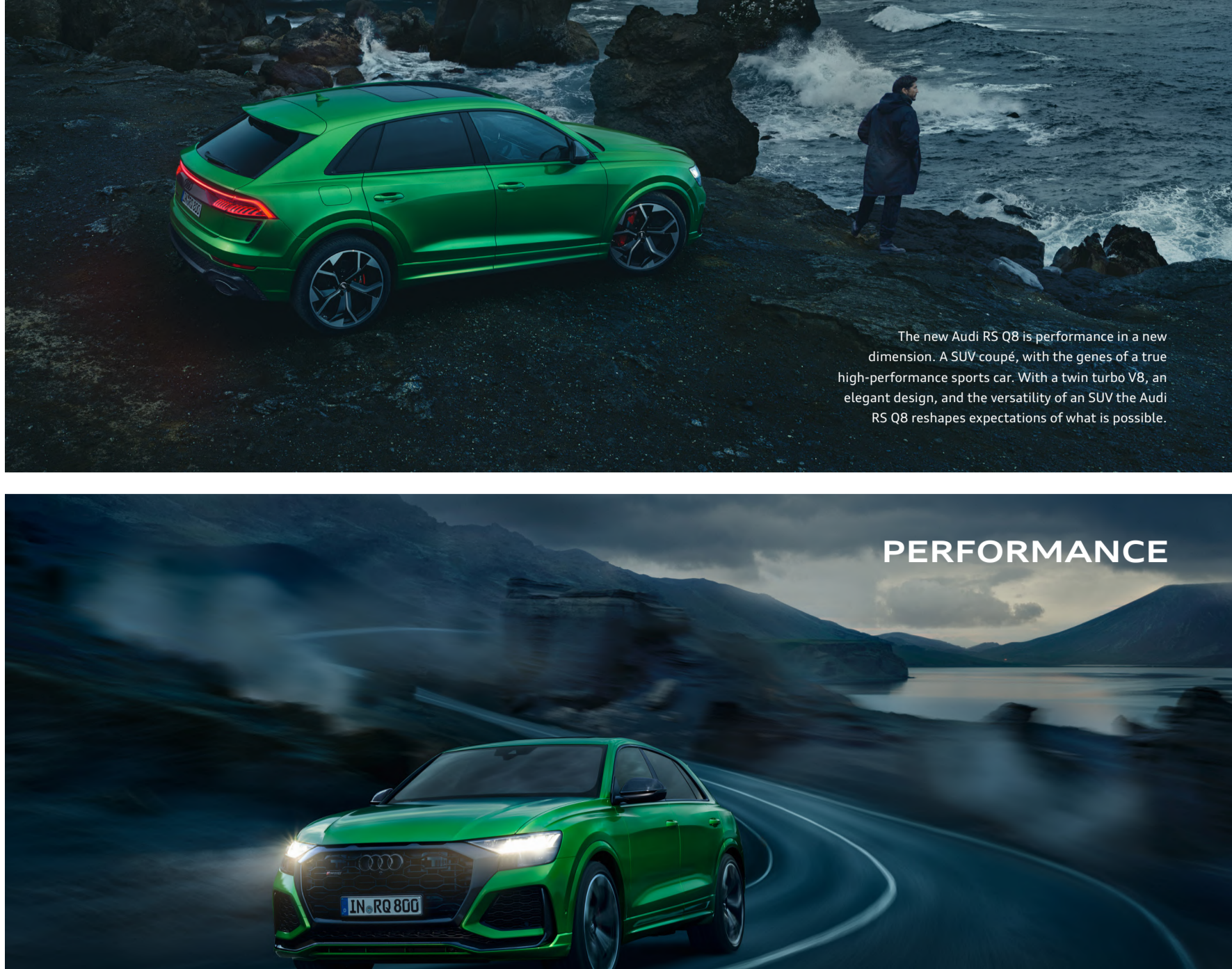

RS Q8

PERFORMANCE IS AN ATTITUDE



The new Audi RS Q8 is performance in a new dimension. A SUV coupé, with the genes of a true high-performance sports car. With a twin turbo V8, an elegant design, and the versatility of an SUV the Audi RS Q8 reshapes expectations of what is possible.

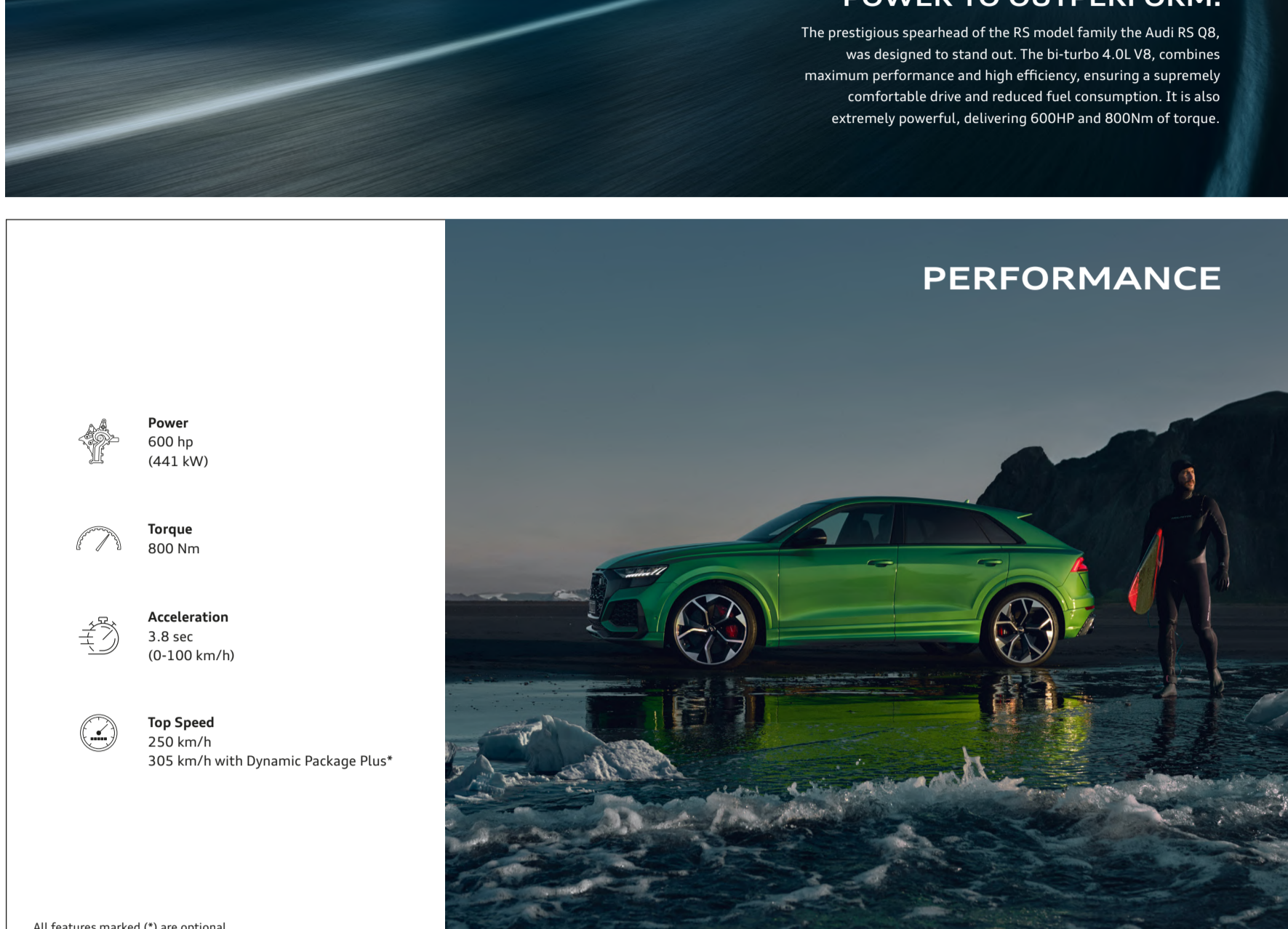

PERFORMANCE

POWER TO OUTPERFORM.

The prestigious spearhead of the RS model family the Audi RS Q8, was designed to stand out. The 670-hp V8, combines maximum performance and high efficiency, ensuring a supremely comfortable drive and reduced fuel consumption. It is also extremely powerful, delivering 600HP and 800Nm of torque.

- Power 600 hp (441 kW)
- Torque 800 Nm
- Acceleration 3.8 sec (0-100 km/h)
- Top Speed 250 km/h (305 km/h with Dynamic Package Plus\*)

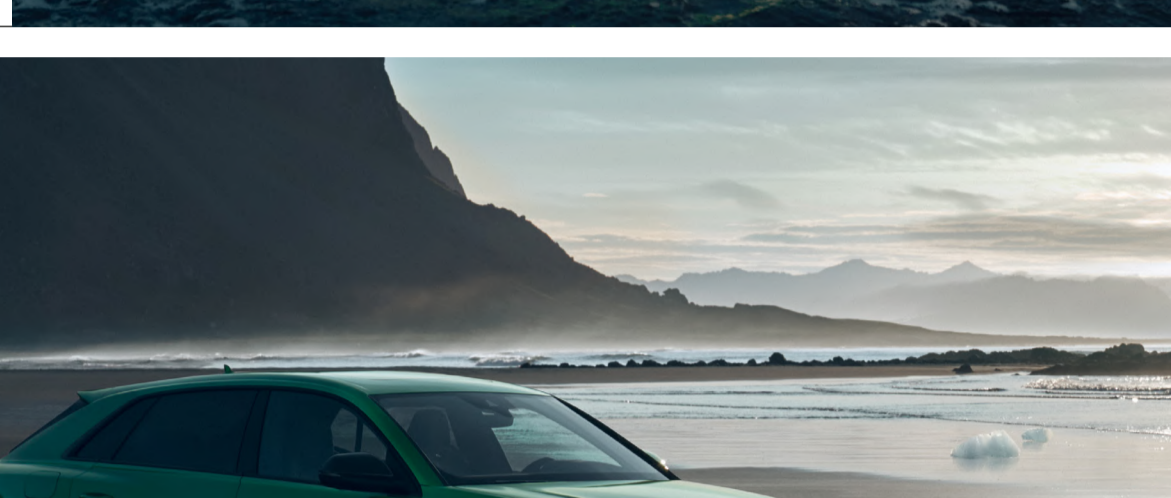

PERFORMANCE

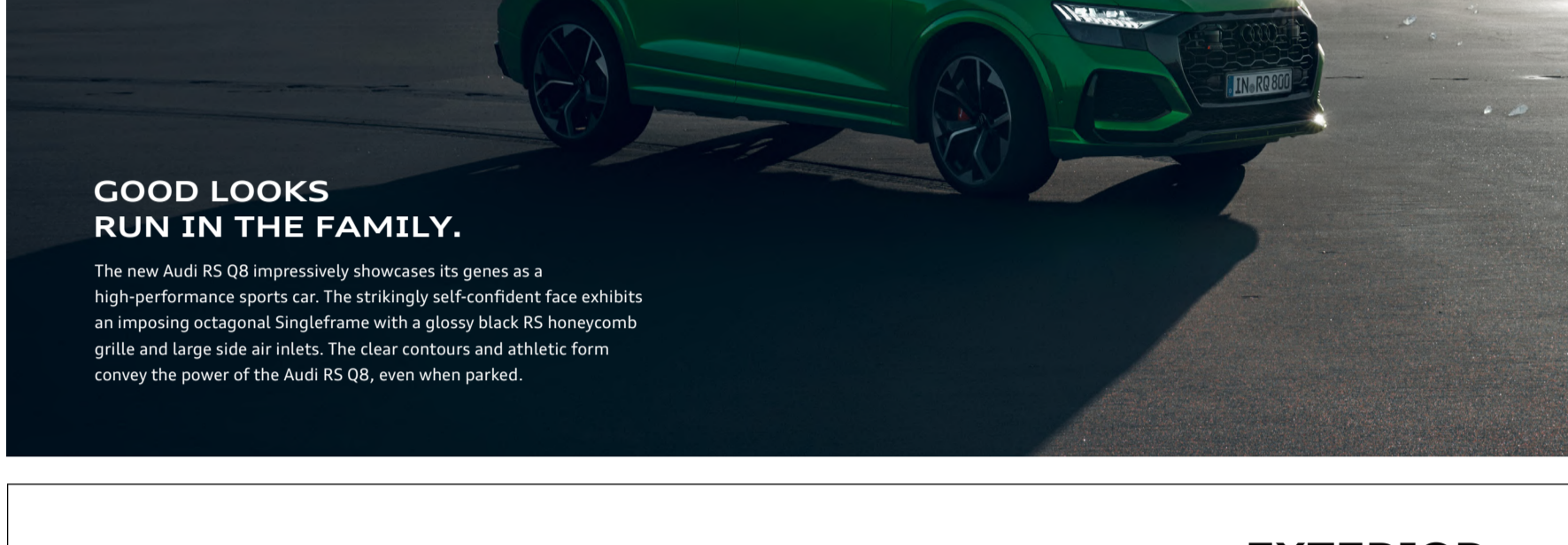

EXTERIOR

GOOD LOOKS RUN IN THE FAMILY.

The new Audi RS Q8 impressively showcases its genes as a high-performance sports car. The strikingly self-confident face exhibits an imposing octagonal Singleframe with a glossy black RS honeycomb grille and large side air inlets. The clear contours and athletic form convey the power of the Audi RS Q8, even when parked.

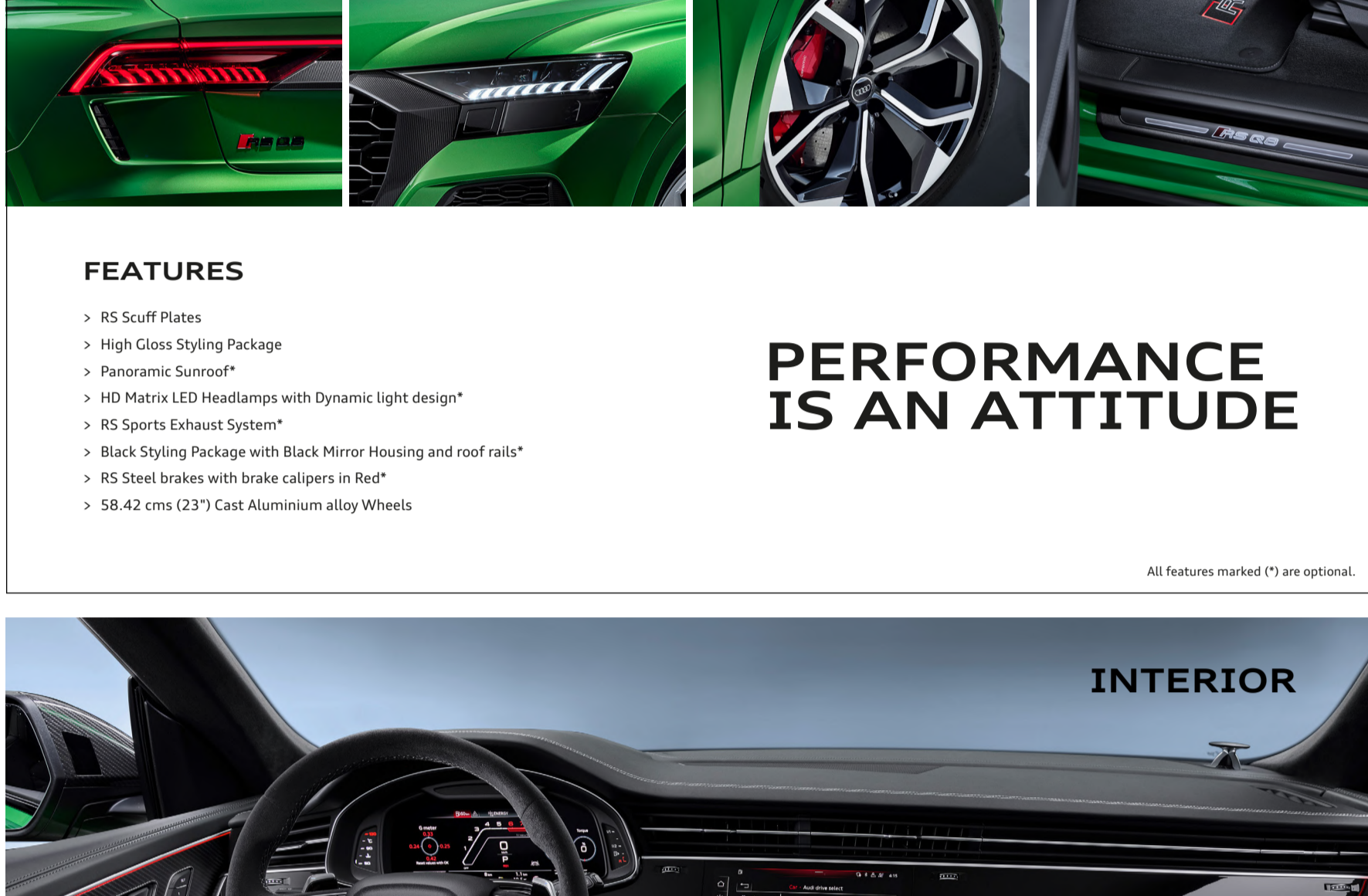

EXTERIOR

FEATURES

- RS Scuff Plates
- High Gloss Styling Package
- Panoramic Sunroof\*
- LED Matrix LED Headlamps with Dynamic light design\*
- RS Sports Exhaust System\*
- Black Styling Package with Black Mirror Housing and roof rails\*
- RS Steel brakes with brake callipers in Red\*
- 58.42 cms (23") Cast Aluminium alloy Wheels

PERFORMANCE IS AN ATTITUDE

All features marked (\*) are optional.

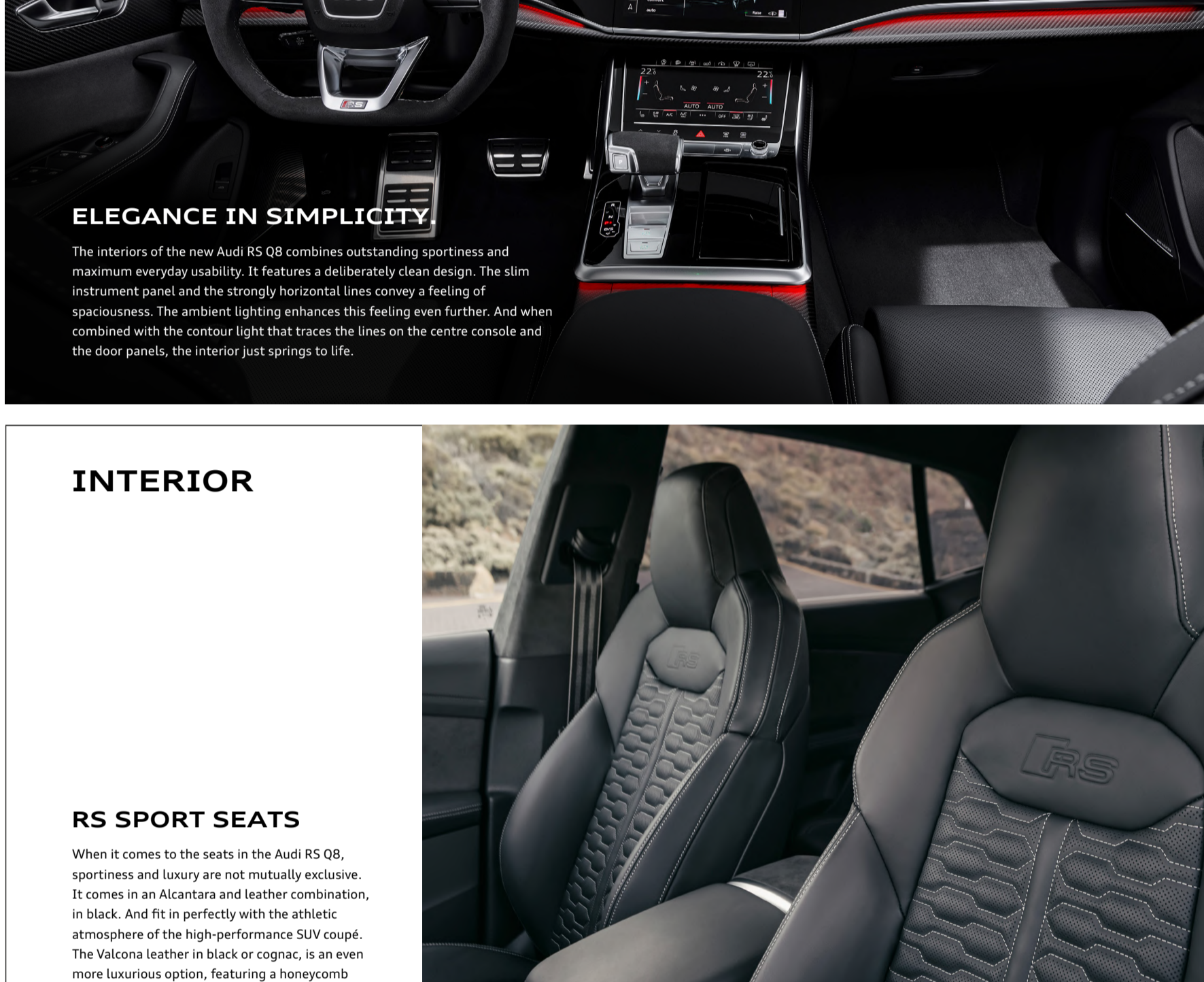

INTERIOR

ELEGANCE IN SIMPLICITY.

The interiors of the new Audi RS Q8 combines outstanding sportiness and maximum everyday usability. It features a deliberately clean design. The slim instrument panel and the strongly horizontal lines convey a feeling of spaciousness. The ambient lighting enhances this feeling even further. And when combined with the contour light that traces the lines on the centre console and the door panels, the interior just springs to life.

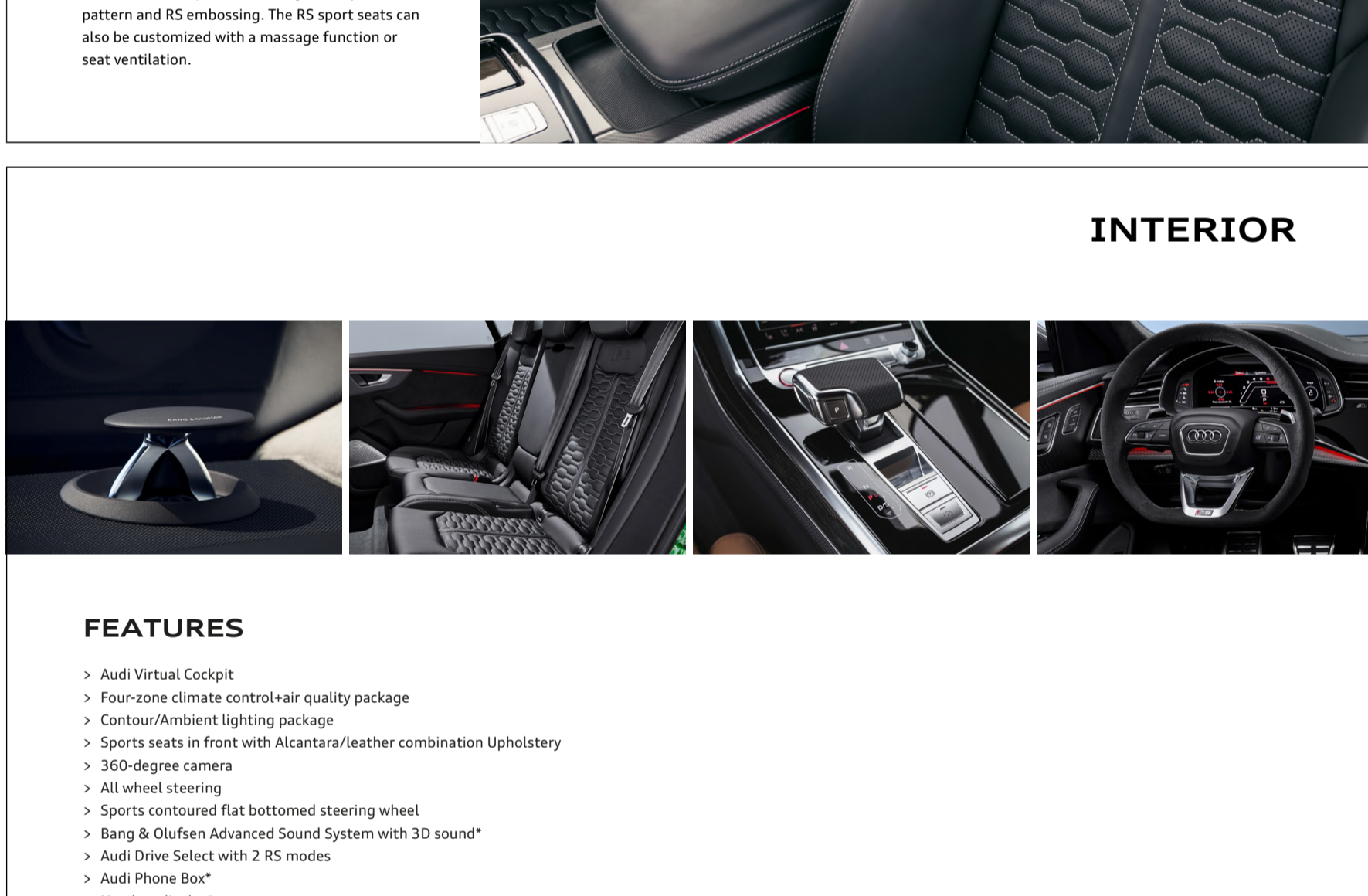

INTERIOR

RS SPORT SEATS

When it comes to the seats in the Audi RS Q8, sportiness and luxury are not mutually exclusive. It comes in an Alcantara and leather combination, in black. And fit in perfectly with the athletic atmosphere of the high-performance SUV coupé.

The Valcona leather in black or cognac, is an even more luxurious option, featuring a honeycomb pattern and RS embossing. The RS sport seats can also be customized with a massage function or seat ventilation.

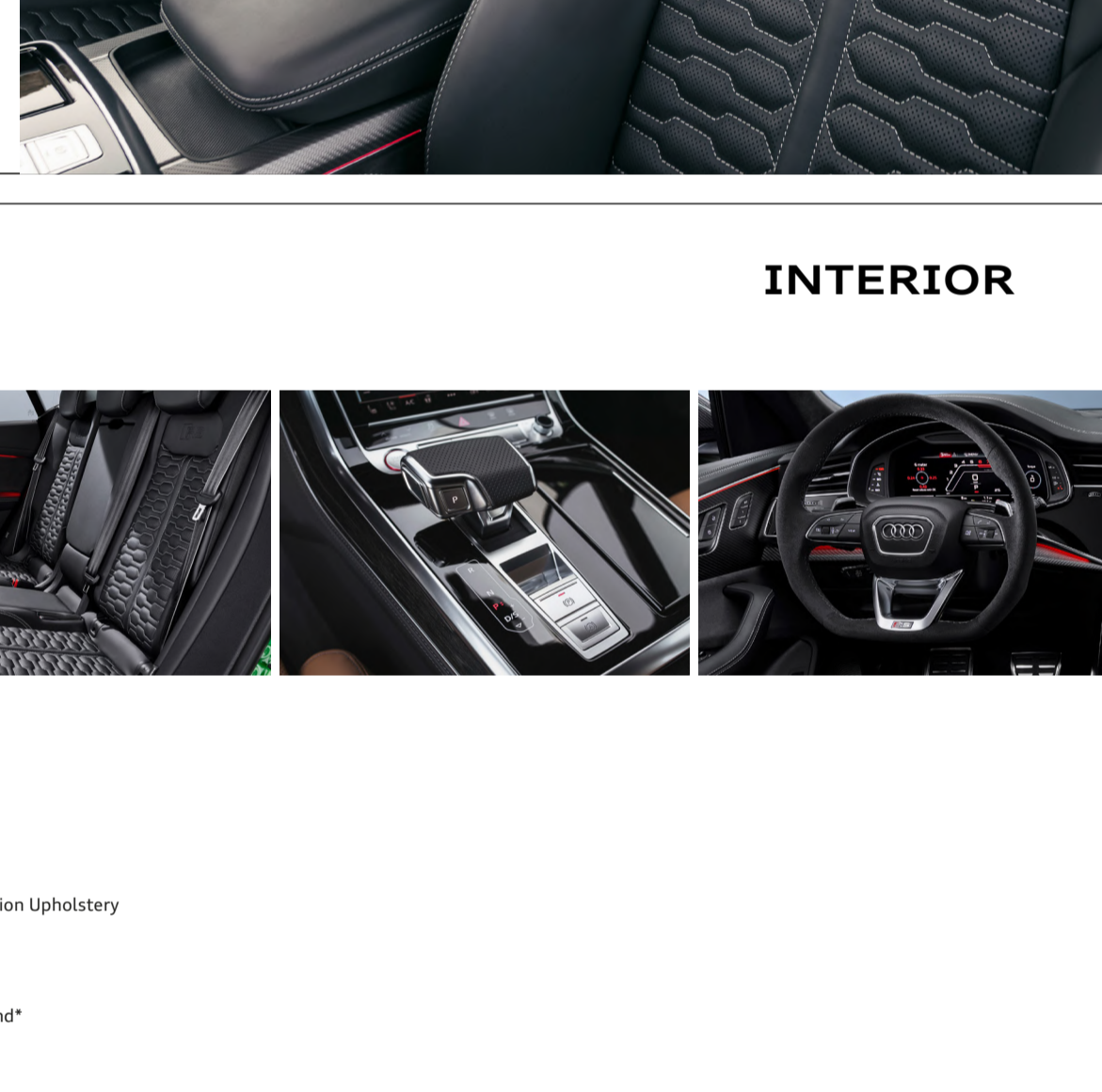

INTERIOR

FEATURES

- Audi Virtual Cockpit
- Four-zone climate control-air quality package
- Contour/Ambient lighting package
- Sports seats in front with Alcantara/leather combination Upholstery
- 360-degree camera
- All wheel steering
- Sports contoured flat bottomed steering wheel
- Bang & Olufsen Advanced Sound System with 3D sound\*
- Audi Drive Select with 2 RS modes
- Audi Phone Box\*
- Head up display\*

All features marked (\*) are optional.

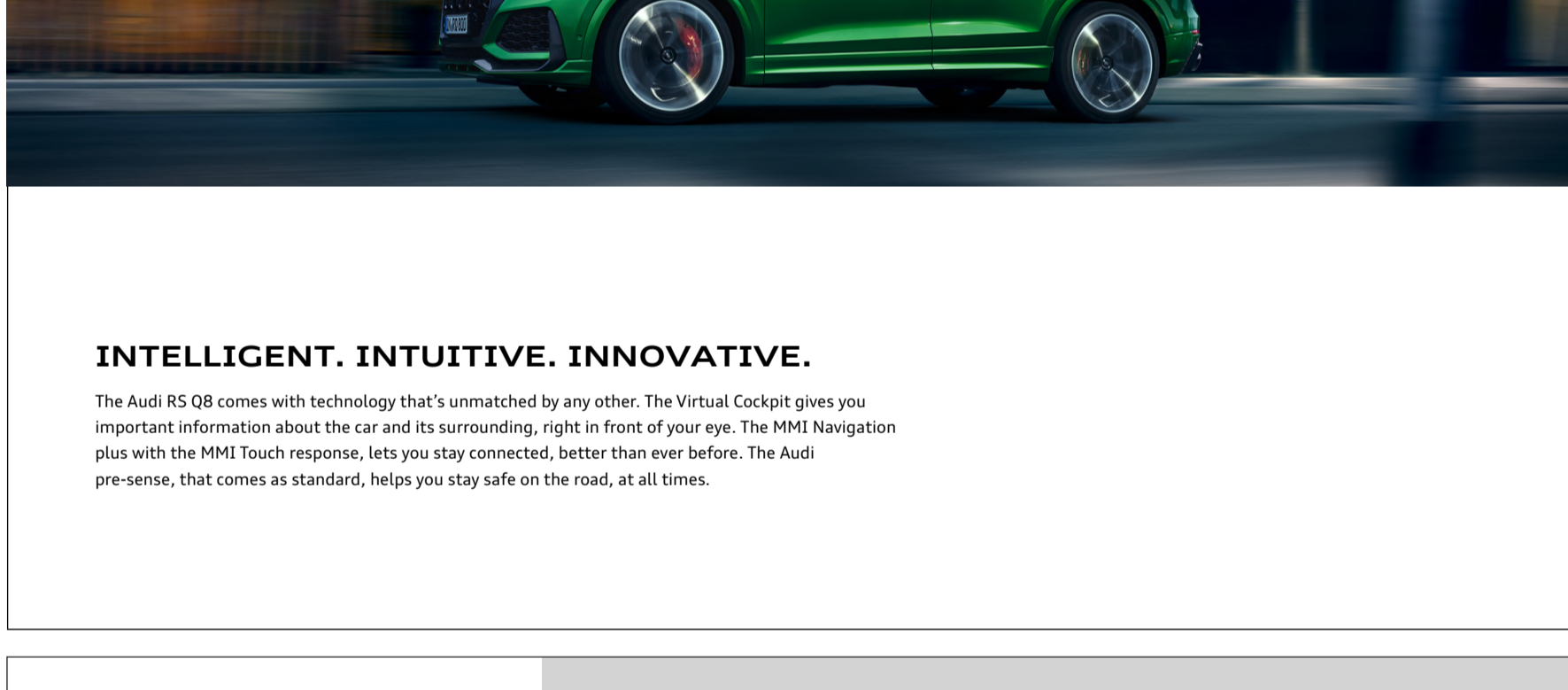

TECHNOLOGY

INTELLIGENT. INTUITIVE. INNOVATIVE.

The Audi RS Q8 comes with technology that's unmatched by any other. The Virtual Cockpit gives you important information about the car and its surrounding, right in front of your eye. The MMI Navigation plus with the MMI Touch response, lets you stay connected, better than ever before. The Audi pre-sense, that comes as standard, helps you stay safe on the road, at all times.

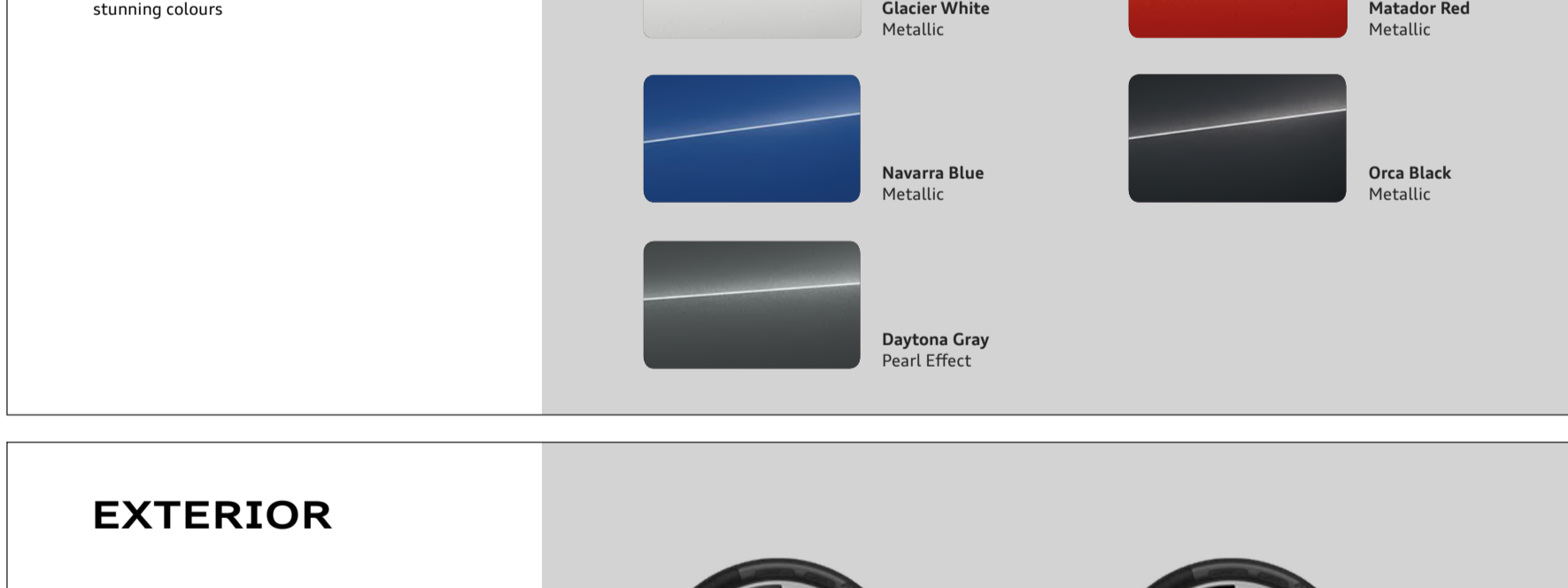

EXTERIOR

COLOURS

The new Audi RS Q8 comes in these stunning colours

- Deep Black Solid
- Dragon Orange Metallic
- Floret Silver Metallic
- Galaxy Blue Metallic
- Glacier White Metallic
- Matador Red Metallic
- Navarra Blue Metallic
- Orca Black Metallic
- Daytona Gray Pearl Effect

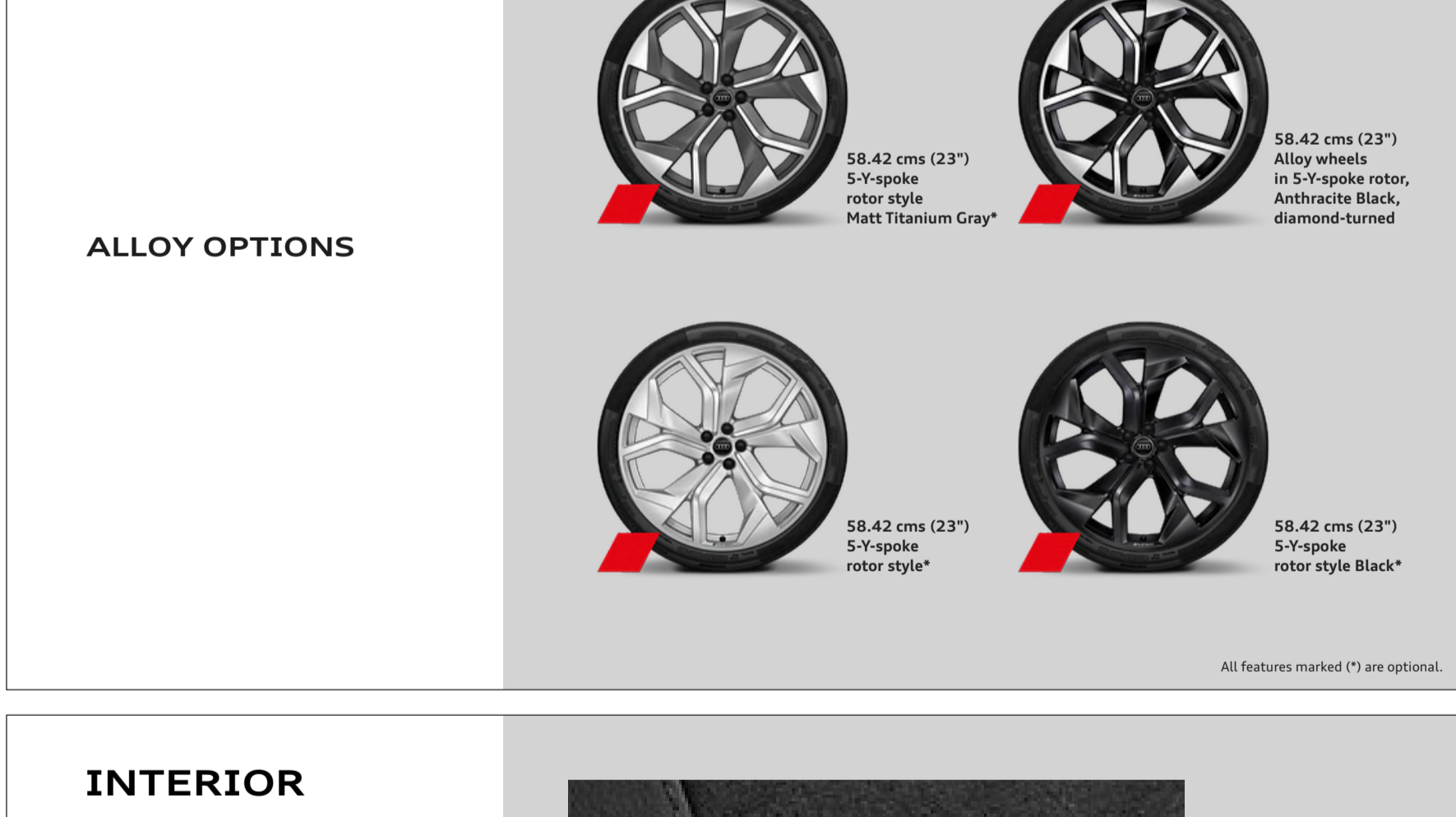

EXTERIOR

ALLOY OPTIONS

- 58.42 cms (23") 5-Y-spoke rotor style Matt Titanium Gray\*
- 58.42 cms (23") Alloy wheels in 5-Y-spoke rotor, Anthracite Black, diamond-turned
- 58.42 cms (23") 5-Y-spoke rotor style\*
- 58.42 cms (23") 5-Y-spoke rotor style Black\*

All features marked (\*) are optional.

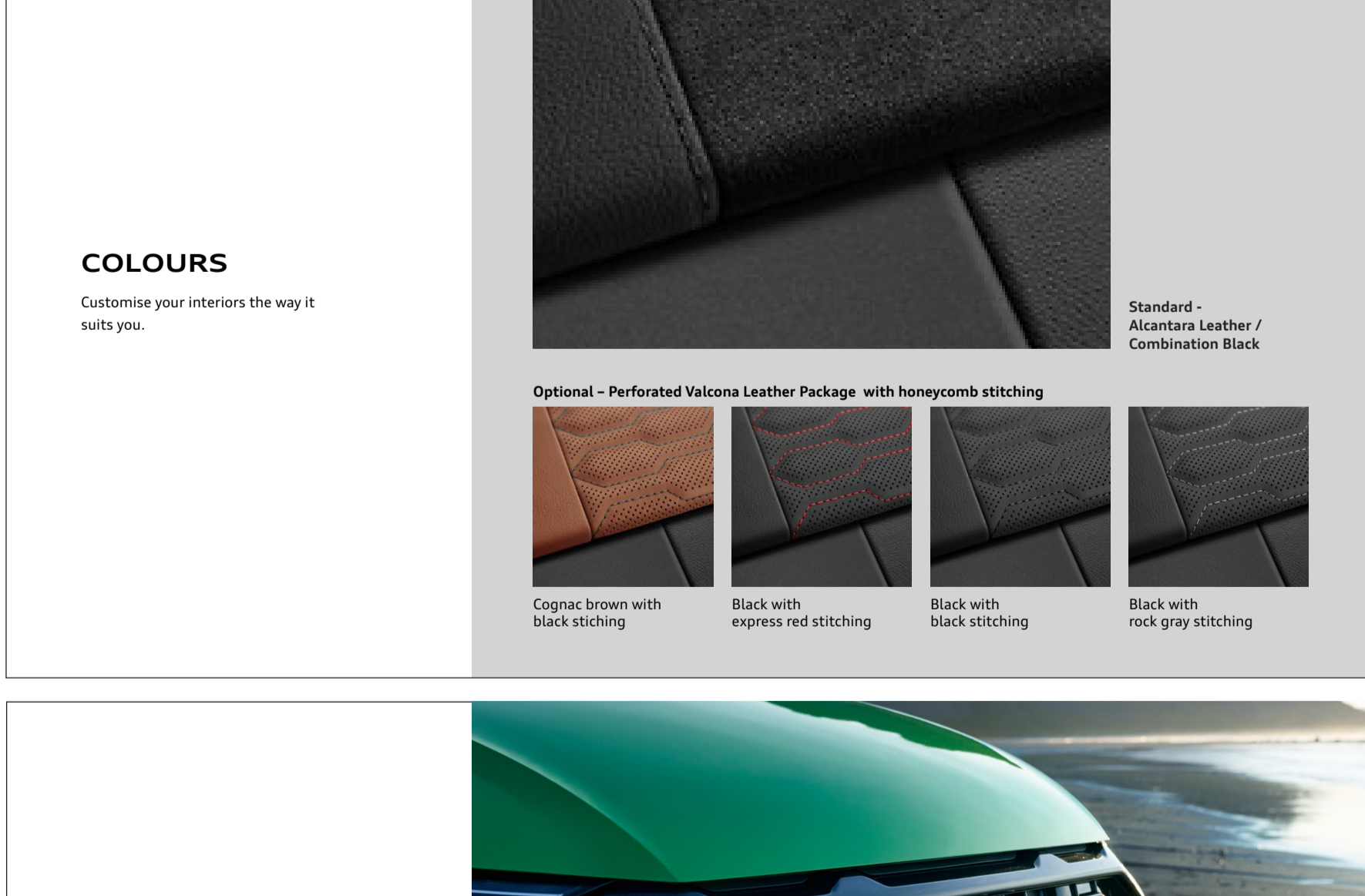

INTERIOR

COLOURS

Customise your interiors the way it suits you.

- Standard - Alcantara Leather / Combination Black
- Optional - Perforated Valcona Leather Package with honeycomb stitching
  - Cognac brown with black stitching
  - Black with express red stitching
  - Black with black stitching
  - Black with rock gray stitching

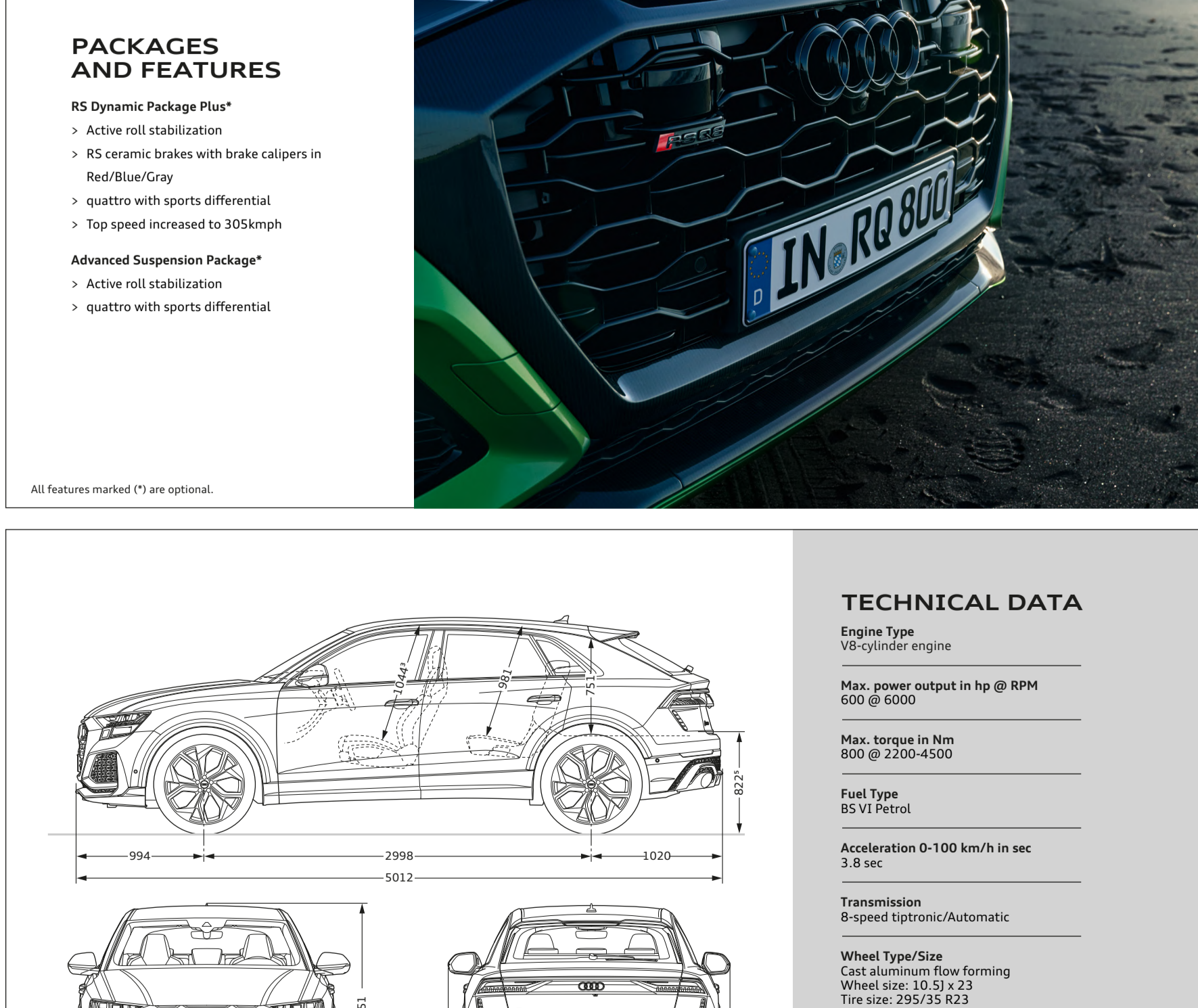

PACKAGES AND FEATURES

RS Dynamic Package Plus\*

- Active roll stabilization
- RS ceramic brakes with brake callipers in Red/Blue/Gray
- quattro with sports differential
- Top speed increased to 305kmph

Advanced Suspension Package\*

- Active roll stabilization
- quattro with sports differential

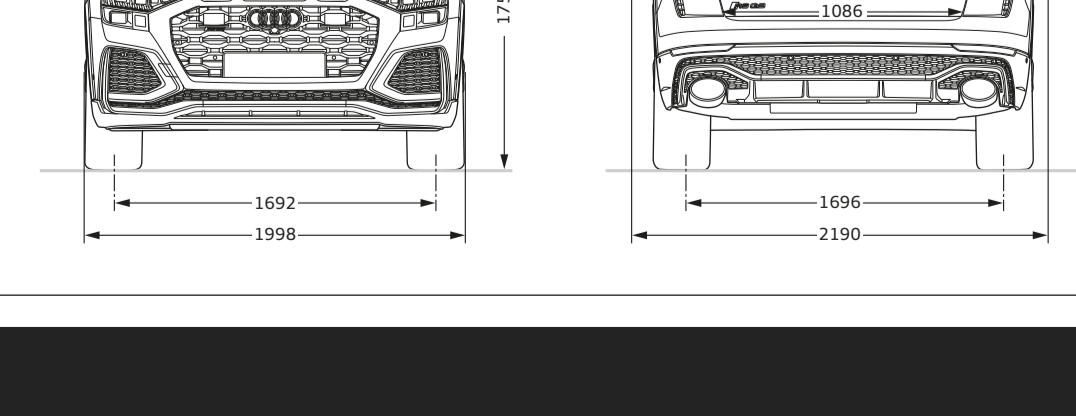

TECHNICAL DATA

- Engine Type V8-cylinder engine
- Max. power output in hp @ RPM 600 @ 6000
- Max. torque in Nm 800 @ 2200-4500
- Fuel Type BS VI Petrol
- Acceleration 0-100 km/h in sec 3.8 sec
- Transmission 8-speed tiptronic/Automatic
- Wheel Type/Size Cast aluminium flow forming Wheel size: 10.5J x 23 Tire size: 295/35 R23
- Kerb weight (kgs) 2390 kgs
- Gross weight (kgs) 3015 kgs
- Fuel Tank (l) 85 l

Audi Vorsprung durch Technik

Audi India, a division of SKODA AUTO Volkswagen India Private Limited (formerly known as Volkswagen India Private Limited) Mumbai - India CIN: U70102PN2007FC133117 www.audi.in

Audi IN | audindia | audindia | Audi IN | Audi IN | Audi Approved | plus | myAudi Connect

The model, colours and equipment versions illustrated and described in this brochure and some of the services listed are not available in all countries. The model and colours of the car illustrated are equipped with optional features for which an extra charge is made. Details concerning the delivery specifications, appearance, performance, dimensions and weights, fuel consumption and running costs of the vehicle were correct to the best of our knowledge at the time of going to press. Deviations from the colours and shapes shown in the illustrations may occur. No liability is accepted for errors and printing errors. The right to introduce modifications is reserved. Not to be reproduced, including in part, without the written approval of AUDI AG.